

Article number: 07109053001

Description: Universal joint single 0.109.053.001
S=128 X= Bore 35 H7 with keyway

Measures

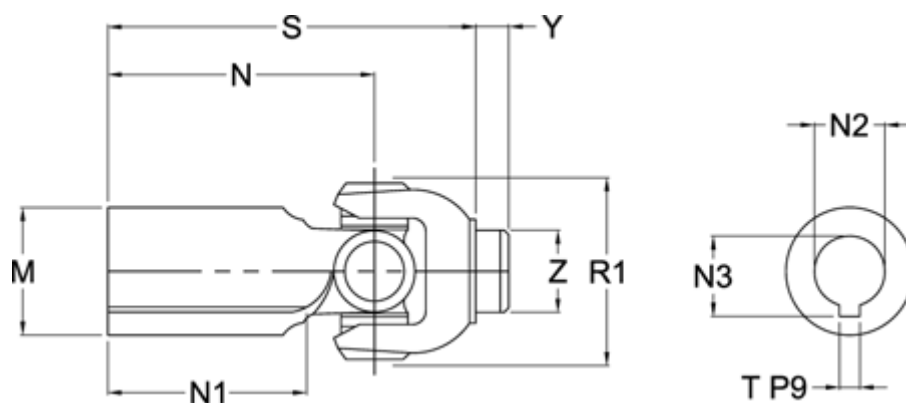

M	= 57	T = 10
Max. Bending Angle degrees	= 20	Y = 14
N	= 80	Z = 46.25
N1	= 50	
N2	= 35 H7	
N3	= 38,3 +0,2	
R1	= 86	
S min	= 128	